

Sunset





Sunset



Comfort

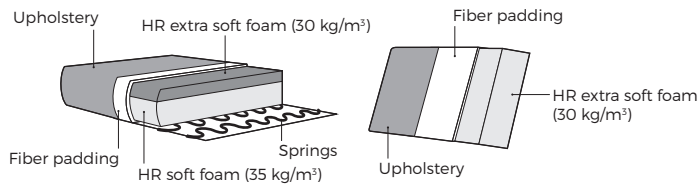

1. Upholstery

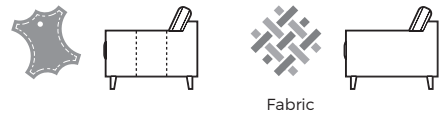

* Leather covers may require more stitches than fabric covers.

2. Headrest type

*Measures with fully opened mechanism

1 Manual ↗

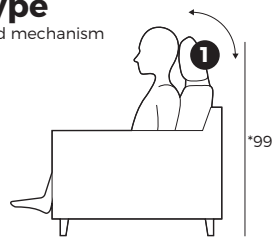

3. Bi-Color option

Color A
Color B

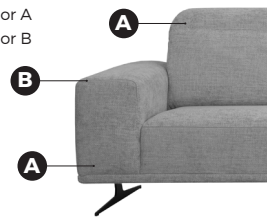

4. Armrest



Sunset
W 27 x D 107 x H 42

5. Legs



511
Metal

IMPORTANT:

Upholstered furniture is handmade using soft materials therefore measurements may vary up to +/- 5 cm.
Parts and sets shown in 2D drawings are left-sided. Parts and sets can be mirrored from left to right.

Single parts

Scale 1:100

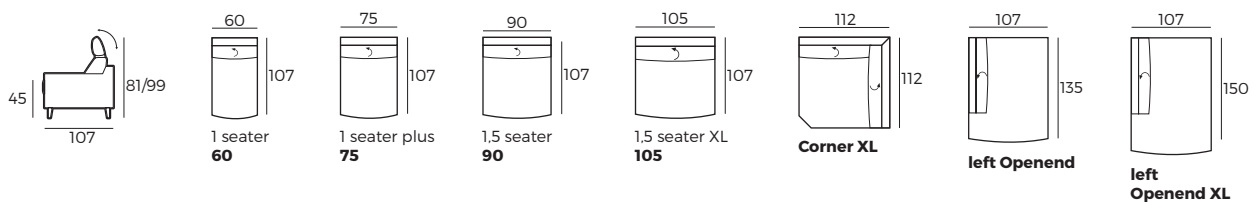

Sunset

Single parts

Scale 1:100

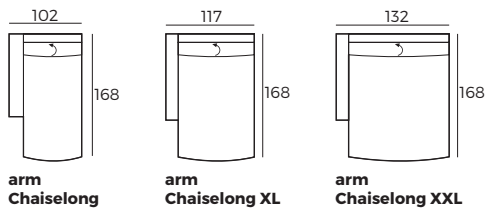

Half sets

Scale 1:100

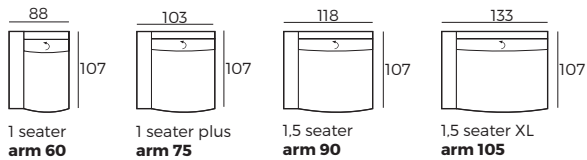

Sets

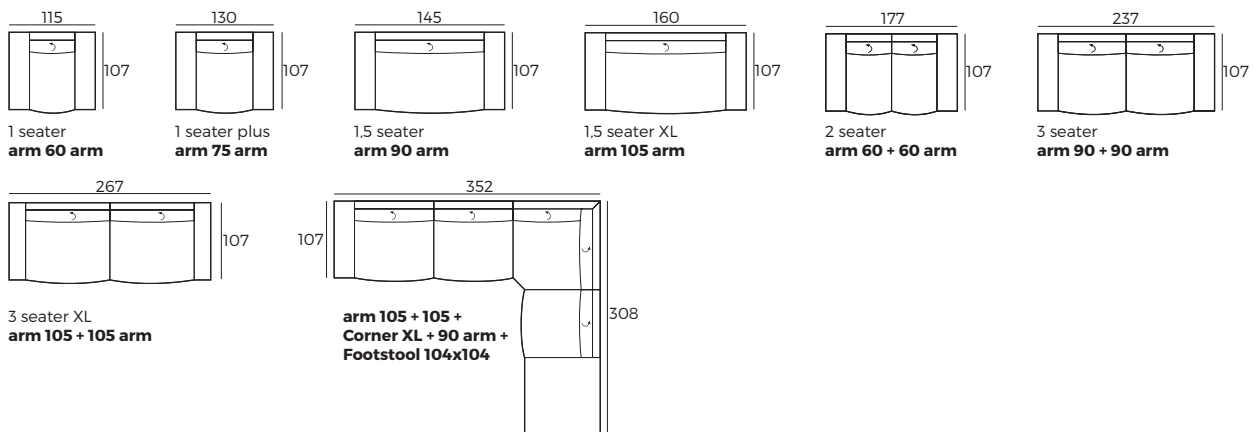

Accessories

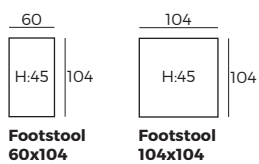

↳ manual: