

BOONE

INTERNATIONAL



NIJVERHEIDSSTRAAT 14
8970 POPERINGE
☎ (+32) 57 33 45 01

VERKOOP@BOONE.BE
VAT BE0428.180.665
WWW.BOONE.BE

2. LOFT VENTURA- Vertikale opklapbedden MET zetel- diepte 45 cm

2. LOFT VENTURA- Lits rabattables verticaux AVEC canapé- profondeur 45 cm

2. LOFT VENTURA- Vertical wallbeds WITH sofa- depth 45 cm

2. LOFT VENTURA- Vertikale Klappbetten mit Sofa- Tiefe 45 cm

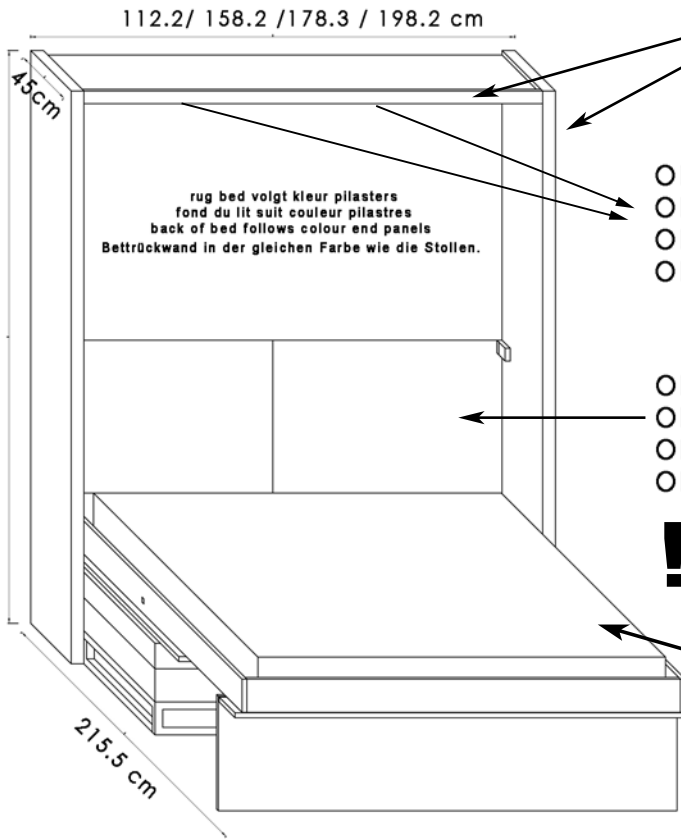

Pilaster + bovenlijst = inbegrepen in structuur bed
 Pilastre + cache horizontal = inclus dans la structure du lit
 End panel + horiz. top list = included in bed structure
 Stollen + Oberleiste sind Teil der Bettkonstruktion

OPTIE: Lees-verlichting (koppaneel)
 OPTION: Eclairage lire (tête du lit)
 OPTION: Reading lights (top panel)
 OPTION: Leseleuchten (Köpfe)

OPTIE: Beklede hoofdstenen
 OPTION: Dossierets capitonnés
 OPTION: Back rests
 OPTION: Gepolsterte Kopfstütze

! In geval van hoofdstenen, matras van 18 cm
 En cas de dossierets capitonnés, matelas de 18 cm
 In case of back rests, mattress of 18 cm
 Wenn Sie Kopfstütze nehmen, Matratze von 18 cm

OPTIE: matras, tot 22cm!
 OPTION: matelas, jusqu' à 22cm!
 OPTION: mattress, up to 22cm!
 OPTION: Matratze bis 22 cm !

LOFT



MAX GEWICHT MATRAS/ WEIGHT MATTRESS

	90 CM	140 CM	160 CM	180 CM
KG	23	38	44	46

Lattenbodem 90 cm = 1-delig
 Lattenbodem 140 cm = 2-delig, geleverd in 1 stuk, demonteerbaar ter plaatse
 Lattenbodem 160 cm = 2-delig, geleverd in 1 stuk, demonteerbaar ter plaatse
 Lattenbodem 180 cm = 2-delig, geleverd in 1 stuk, demonteerbaar ter plaatse

Sommier à lattes 90 cm = 1 partie
 Sommier à lattes 140cm = 2 parties- livré en 1 pièce- démontable sur site
 Sommier à lattes 160cm = 2 parties- livré en 1 pièce- démontable sur site
 Sommier à lattes 180cm = 2 parties- livré en 1 pièce- démontable sur site

Slatted base 90 cm = 1 part
 Slatted base 140 cm = delivered in 1 piece, can be taken to pieces on site
 Slatted base 160 cm = delivered in 1 piece, can be taken to pieces on site
 Slatted base 180 cm = delivered in 1 piece, can be taken to pieces on site

Lattenrost 90 cm = einteilig
 Lattenrost 140 cm = 2-teilig montiert geliefert, vor Ort demontierbar
 Lattenrost 160 cm = 2-teilig montiert geliefert, vor Ort demontierbar
 Lattenrost 180 cm = 2-teilig montiert geliefert, vor Ort demontierbar

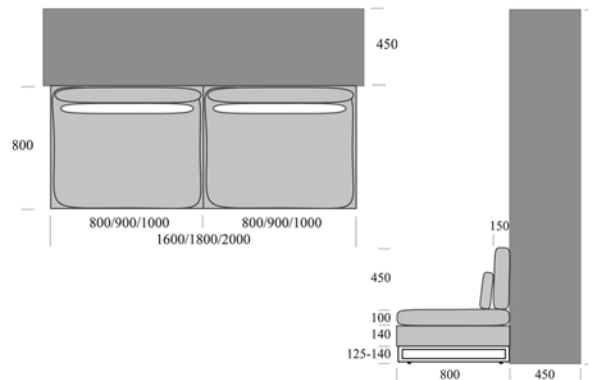
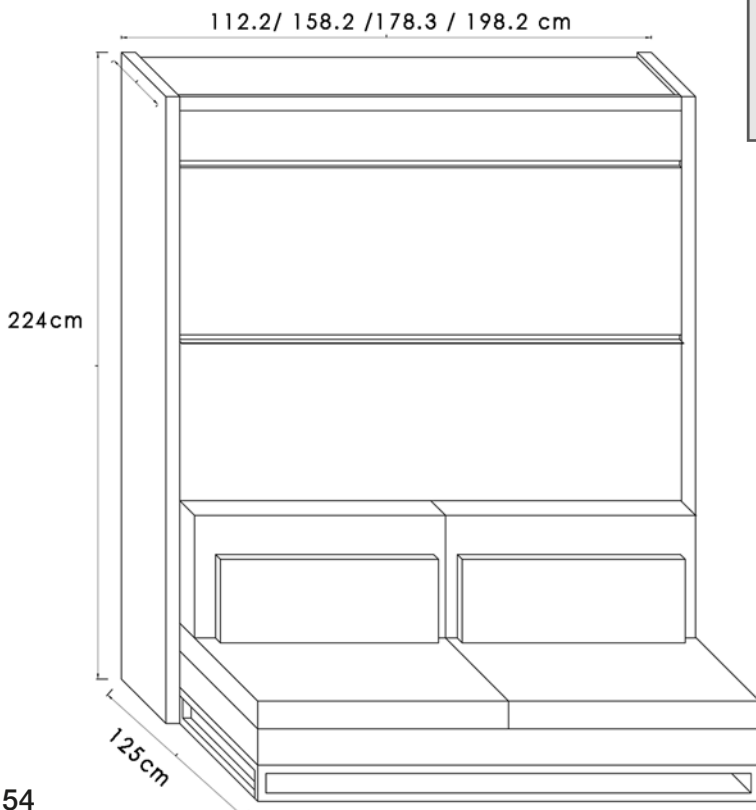

STOF/TISSU/TISSUE/STOFF	REF.	CODE
grijs/gris/grey/grau	140L/150L/170L/180L	E56629
bruin/grijs/ gris brun/ brown grey/ braungrau	141L/151L/171L/181L	E56625
zand/sable/sand/sand	142L/152L/172L/182L	F12320
LEDER/CUIR/LEATHER/LEDER	REF.	CODE
beige/beige/beige	240L/250L/270L/280L	W41725
bruin/brun/brown/braun	241L/251L/271L/281L	W41722
zwart/noir/black/schwarz	242L/252L/272L/282L	W41790

2.1 Lit 2 personnes - 112,2 cm (couchage intérieur 90x200cm)- PROF. 45 cm

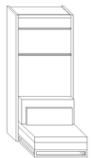
	BLANC +		LIT		REF.	MATELAS		
	ch.clair	1504S			04MAS	Masarat, Mousse à froid, HR60 (souple)90x200x22cm		
	ch.foncé	1604S			04MAS+	Masarat, Mousse à froid , HR55 (ferme)90x200x22cm		
	noyer	1704S			04AMB	Ambiance, Pocket, HR60 (souple) 90x200x21cm		
	blanc (uni)	1804S			04AMB+	Ambiance, Pocket, HR55 (ferme) 90x200x21cm		
+ CHOIX CANAPE: TISSU			+ CHOIX CANAPE: CUIR			OPTION DOSSERET		
	REF.			REF.			REF.	
gris	140L		beige	240L		gris	D130	
gris brun	141L		brun	241L		gris brun	D131	
sable	142L		noir	242L		sable	D132	
1076N	éclairage lire, 1 LED					MATCH:		
EL04	option : sommier à lattes électrique TPR					HAUTE BRILL.		

2.1 Lit 2 personnes - 158,2 cm (couchage intérieur 140x200cm)- PROF. 45 cm

	BLANC +		LIT		REF.	MATELAS		
	ch.clair	1505S			05MAS	Masarat, Mousse à froid, HR60 (souple)140x200x22cm		
	ch.foncé	1605S			05MAS+	Masarat, Mousse à froid , HR55 (ferme)140x200x22cm		
	noyer	1705S			05MASEL	Surplus matelas en 2 parties pour sommier électrique TPR		
	blanc (uni)	1805S			05AMB+	Ambiance, Pocket, HR55 (ferme) 140x200x21cm		
				05AMB	Ambiance, Pocket, HR60 (souple) 140x200x21cm			
				05AMBEL	Surplus matelas en 2 parties pour sommier électrique TPR			
+ CHOIX CANAPE: TISSU			+ CHOIX CANAPE: CUIR			OPTION DOSSERET		
	REF.			REF.			REF.	
gris	150L		beige	250L		gris	D140	
gris brun	151L		brun	251L		gris brun	D141	
sable	152L		noir	252L		sable	D142	
1077N	éclairage lire, 2 LED					MATCH:		
EL05	option : sommier à lattes électrique TPR					HAUTE BRILL.		

2.2 Lit 2 personnes - 178,3 cm (couchage intérieur 160x200cm)- PROF. 45 cm

	BLANC +		LIT		REF.	MATELAS		
	ch.clair	1507S			07MAS	Masarat, Mousse à froid, HR60 (souple)160x200x22cm		
	ch.foncé	1607S			07MAS+	Masarat, Mousse à froid , HR55 (ferme)160x200x22cm		
	noyer	1707S			07MASEL	Surplus matelas en 2 parties pour sommier électrique TPR		
	blanc (uni)	1807S			07AMB+	Ambiance, Pocket, HR55 (ferme) 160x200x21cm		
				07AMB	Ambiance, Pocket, HR60 (souple) 160x200x21cm			
				07AMBEL	Surplus matelas en 2 parties pour sommier électrique TPR			
+ CHOIX CANAPE: TISSU			+ CHOIX CANAPE: CUIR			OPTION DOSSERET		
	REF.			REF.			REF.	
gris	170L		beige	270L		gris	D160	
gris brun	171L		brun	271L		gris brun	D161	
sable	172L		noir	272L		sable	D162	
1077N	éclairage lire, 2 LED					MATCH:		
EL07	option : sommier à lattes électrique TPR					HAUTE BRILL.		

2.3 2-Lit 2 personnes - 198,2 cm (couchage intérieur 180x200cm)- PROF. 45 cm

	BLANC +		LIT		REF.	MATELAS		
	ch.clair	1508S			08MAS	Masarat, Mousse à froid, HR60 (souple)180x200x22cm		
	ch.foncé	1608S			08MAS+	Masarat, Mousse à froid , HR55 (ferme)180x200x22cm		
	noyer	1708S			08MASEL	Surplus matelas en 2 parties pour sommier électrique TPR		
	blanc (uni)	1808S			08AMB+	Ambiance, Pocket, HR55 (ferme) 180x200x21cm		
				08AMB	Ambiance, Pocket, HR60 (souple) 180x200x21cm			
				08AMBEL	Surplus matelas en 2 parties pour sommier électrique TPR			
+ CHOIX CANAPE: TISSU			+ CHOIX CANAPE: CUIR			OPTION DOSSERET		
	REF.			REF.			REF.	
gris	180L		beige	280L		gris	D180	
gris brun	181L		brun	281L		gris brun	D181	
sable	182L		noir	282L		sable	D182	
1077N	éclairage lire, 2 LED					MATCH:		
EL08	option : sommier à lattes électrique TPR					HAUTE BRILL.		

5. Pilasters & bibliotheken

5. Pilastres & bibliothèques

5. End panels & library units

5. Stollen & Bücherregalen

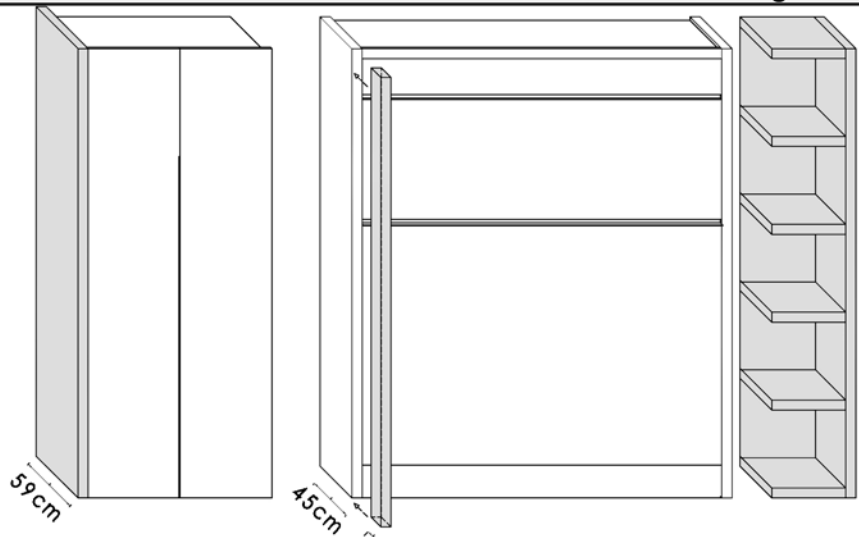

Aanbouwbibliotheek: 45cm diep
 Bibliothèque complémentaire: prof. 45cm
 Build-on library: depth 45cm
 Anbaubücherregal: Tiefe 45 cm

LOFT

Aanzetpilaster (D:14cm) voor diepteverschil bed-hangkast
 Pilastre d'ajoute (P:14cm) pour différence profondeur lit-garderobe
 Build-on end panel (D:14cm) for depth difference bed-wardrobe
 Anbaustollen (T:14 cm) aufgrund der unterschiedlichen Tiefe des Betts
 und des Kleiderschranks mit Kleiderstange

Pilaster: 59cm diep
 Pilastre: profondeur 59cm
 End panel: depth 59cm
 Stollen: Tiefe 59 cm

Links / Gauche / Left

Rechts / Droite / Right

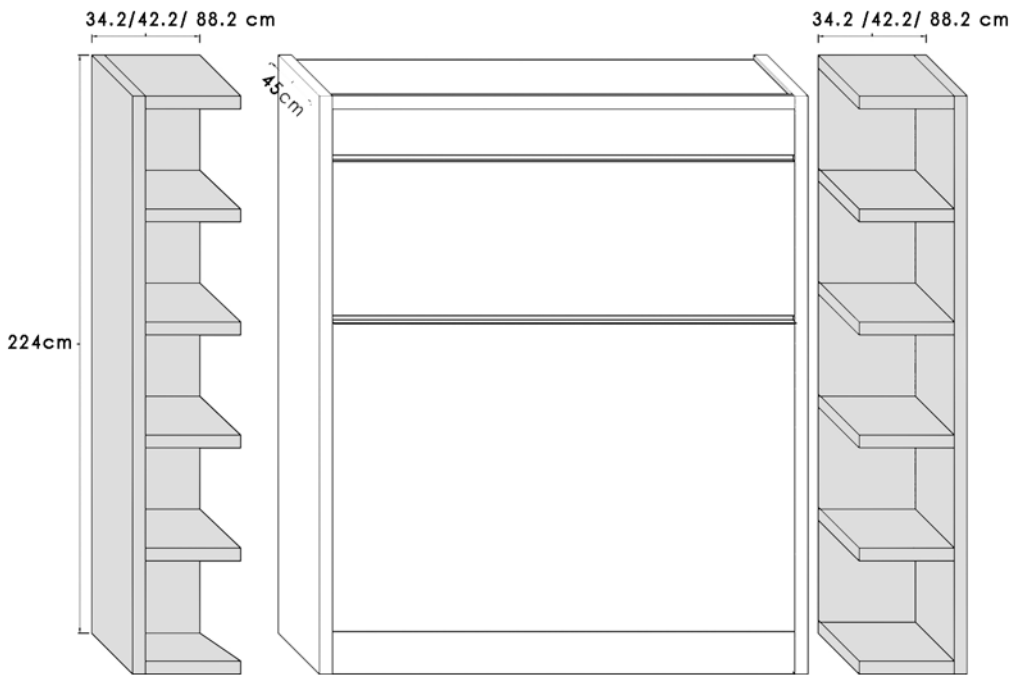



* ZIE OOK: SMART §3 voor verdere uitleg pilasters
 * VOIR AUSSI: SMART §3 pour autre renseignements pilastres
 * SEE ALSO: SMART § for further explication end panels
 * SIEHE AUCH: SMART §3 für mehr Informationen über Stollen

5. Pilastres & Bibliothèques

PILASTRE = 3,8 cm

PILASTRE Profondeur 45cm			
	coul. d'accent:	REF.	
	chêne clair	1568	
	chêne foncé	1668	
	noyer	1768	
	blanc (uni)	1868	

PILASTRE Profondeur 59cm			
	coul. d'accent:	REF.	
	chêne clair	1569	
	chêne foncé	1669	
	noyer	1769	
	blanc (uni)	1869	

PILASTRE D'AJOUTE LIT (Prof.14cm)			
	coul. d'accent:	REF.	
	chêne clair	1568A	
	chêne foncé	1668A	
	noyer	1768A	
	blanc (uni)	1868A	

BIBLIOTHEQUES PROFONDEUR 59 cm			
BIBLIOTHEQUE 46cm			
	coul. d'accent:	REF.	
	chêne clair	1520D	
	chêne foncé	1620D	
	noyer	1720D	
	blanc (uni)	1820D	

BIBLIOTHEQUES PROFONDEUR 45 cm

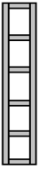
LARGEUR 38 CM			
	coul. d'accent:	REF.	
	chêne clair	1510	
	chêne foncé	1610	
	noyer	1710	
	blanc (uni)	1810	

LARGEUR 45 CM			
	coul. d'accent:	REF.	
	chêne clair	1520	
	chêne foncé	1620	
	noyer	1720	
	blanc (uni)	1820	

LARGEUR 92 CM			
	coul. d'accent:	REF.	
	chêne clair	1550	
	chêne foncé	1650	
	noyer	1750	
	blanc (uni)	1850	

LARGEUR 34,2 cm (gauche)			
	coul. d'accent:	REF.	
	chêne clair	1510L	
	chêne foncé	1610L	
	noyer	1710L	
	blanc (uni)	1810L	

LARGEUR 34,2 cm (droite)			
	coul. d'accent:	REF.	
	chêne clair	1510R	
	chêne foncé	1610R	
	noyer	1710R	
	blanc (uni)	1810R	

LARGEUR 43,2 cm (gauche)			
	coul. d'accent:	REF.	
	chêne clair	1520L	
	chêne foncé	1620L	
	noyer	1720L	
	blanc (uni)	1820L	

LARGEUR 43,2 cm (droite)			
	coul. d'accent:	REF.	
	chêne clair	1520R	
	chêne foncé	1620R	
	noyer	1720R	
	blanc (uni)	1820R	

LARGEUR 88,2 cm (gauche)			
	coul. d'accent:	REF.	
	chêne clair	1550L	
	chêne foncé	1650L	
	noyer	1750L	
	blanc (uni)	1850L	

LARGEUR 88,2 cm (droite)			
	coul. d'accent:	REF.	
	chêne clair	1550R	
	chêne foncé	1650R	
	noyer	1750R	
	blanc (uni)	1850R	

6. Hangkasten & legkasten

6. Garderobes & lingères

6. Wardrobes & cupboards

6. Kleiderschrank & Schrank mit Einlegeböden

6.A. Hangkasten / Garderobes / Wardrobes/ Kleiderschrank

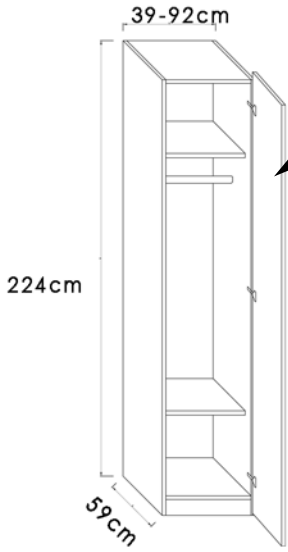

- 2 legplanken + kastbaar inbegrepen
- 2 étagères + tringle inclus
- 2 shelves + hanging rail included
- 2 Einlegeböden + inklusive Kleiderstange

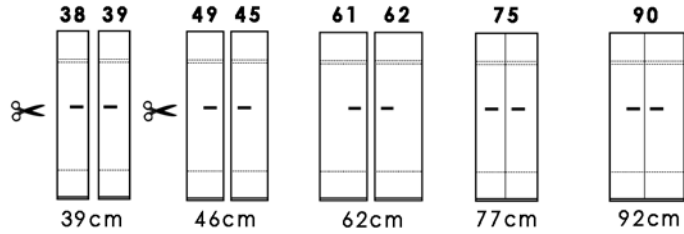

LOFT

6.B. Legkasten / Lingères / Cupboards/ Schrank mit Einlegeböden

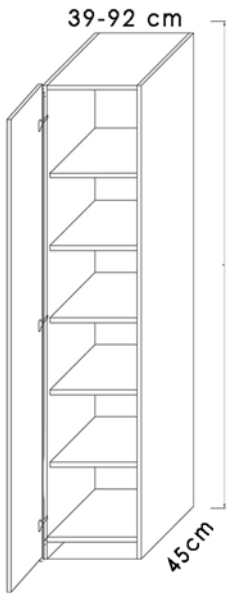

- 5 legplanken inbegrepen
- 5 étagères inclus
- 5 shelves included
- 5 Einlegeböden inklusive

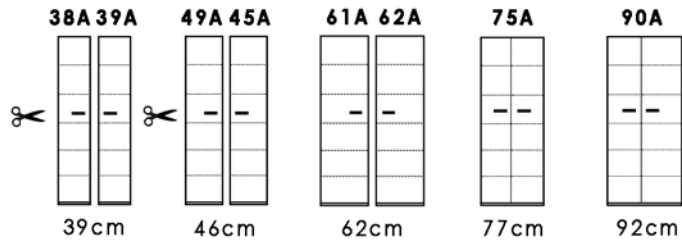

Voor maatwerk: minimum 4cm van de standaardmaat aftrekken
 Armoire sur mesure: décompter un minimum de 4cm de la mesure standard
 Cut to size: minimum deduction of 4cm required
 Bei Spezialanfertigungen: mindestens 4 cm von den Standardmaßen abziehen

6.C. Hoekkasten / Armoires d'angle / Corner wardrobes/ Eckschränken

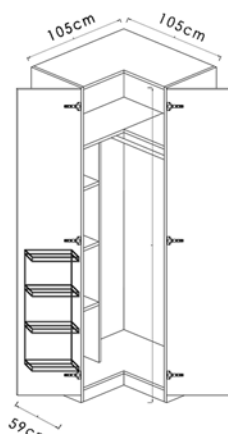
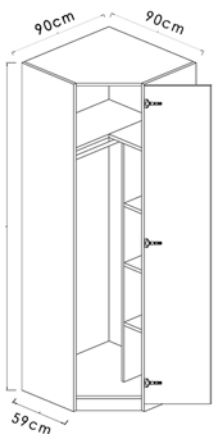

6.A. Garderobes (Profondeur 59cm)

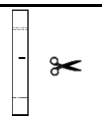
39cm (gauche)	REF.	
 blanc	1038	

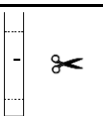
46cm (gauche)	REF.	
 blanc	1049	

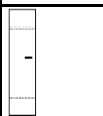
62cm (gauche)	REF.	
 blanc	1061	

39cm (droite)	REF.	
 blanc	1039	

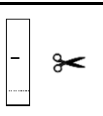
46cm (droite)	REF.	
 blanc	1045	

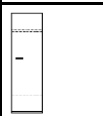
62cm (droite)	REF.	
 blanc	1062	

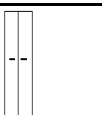
77cm	REF.	
 blanc	1075	

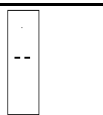
92cm	REF.	
 blanc	1090	

+ PILASTRES!		
voir page précédente		

6.B. Lingères (profondeur 45cm)

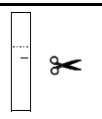
39cm (gauche)	REF.	
 blanc	1038A	

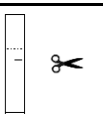
46cm (gauche)	REF.	
 blanc	1049A	

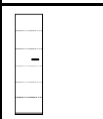
62cm (gauche)	REF.	
 blanc	1061A	

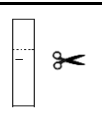
39cm (droite)	REF.	
 blanc	1039A	

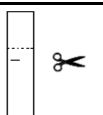
46cm (droite)	REF.	
 blanc	1045A	

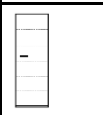
62cm (droite)	REF.	
 blanc	1062A	

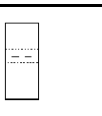
77cm	REF.	
 blanc	1075A	

92cm	REF.	
 blanc	1090A	

+ PILASTERS!		
voir page précédente		

 SUR MESURE (L, P, H)
= supplément:
décompter au minimum 4cm de la mesure standard

OPTIONS
étagère, tringle, rangement int. bloc tiroir,... VOIR RUBRIQUE OPTIONS

MATCH
voir rubrique MATCH
39-46cm - couleurs laque
62-92cm - couleurs laque
39-46cm - bl. haute brill.
62-92cm - bl. haute brill.

6.C. Armoires d'angle

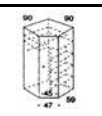
90x90cm	REF.	
 blanc	1018	

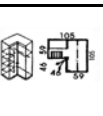
105x105cm	REF.	
 blanc	H1015	

MATCH
voir rubrique MATCH
90x90cm - couleurs laque
105x105cm - coul. laque
90x90cm - bl. haute brill.
105x105cm - bl. haute brill.