

BOONE

INTERNATIONAL



NIJVERHEIDSSTRAAT 14
8970 POPERINGE
☎ (+32) 57 33 45 01

VERKOOP@BOONE.BE
VAT BE0428.180.665
WWW.BOONE.BE

4. TWINS - Stapelbed - diepte 45 cm

4. TWINS - Lit superposé - profondeur 45 cm

4. TWINS - Bunkbed - depth 45 cm

4. TWINS - Etagenbett - Tiefe 45 cm

LOFT

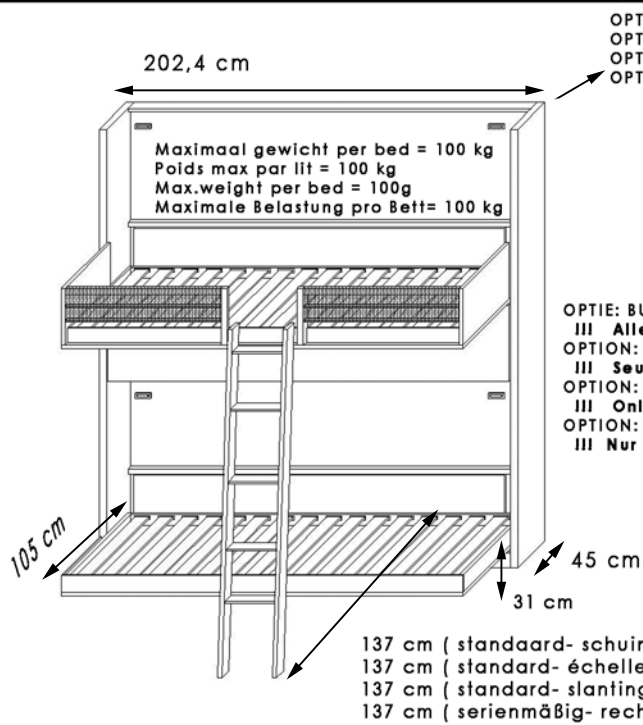

OPTIE: LED verlichting (aan beide zijden) + USB
OPTION: Eclairage LED (à chaque côté) + USB connexion
OPTION: LED Lights (o n both sides) + USB connection
OPTION: Leseleuchten (an beiden Seiten) + USB Anschluss

OPTIE: BUREAU (stopcontact + USB)
III Alleen bij slaapmaat 80x190
OPTION: BUREAU (prise + USB)
III Seulement avec couchage 80x190
OPTION: DESK (power-point + USB)
III Only by sleeping size 80x190
OPTION: BÜRO (Steckdose + USB)
III Nur bei Liegefläche 80x190

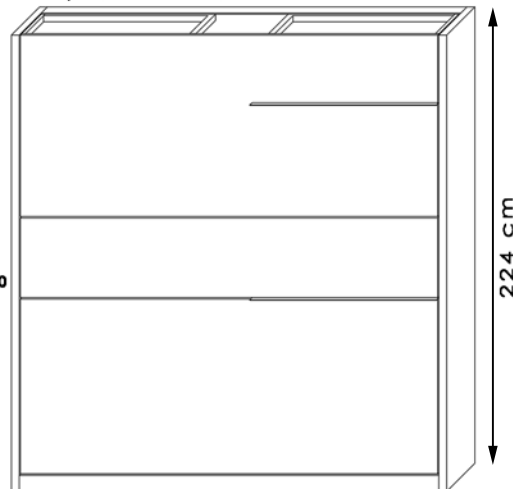

Lattenbodem met dubbele rotulen
Sommier à lattes avec double rotules
Slatted base with double slat holders
Lattenboden mit doppelten Lattenhaltern

* 122 cm (optie- rechte ladder)
* 122 cm (option- échelle droite)
* 122 cm (option- straight ladder)
* 122 cm (Option- schiefe Leiter)

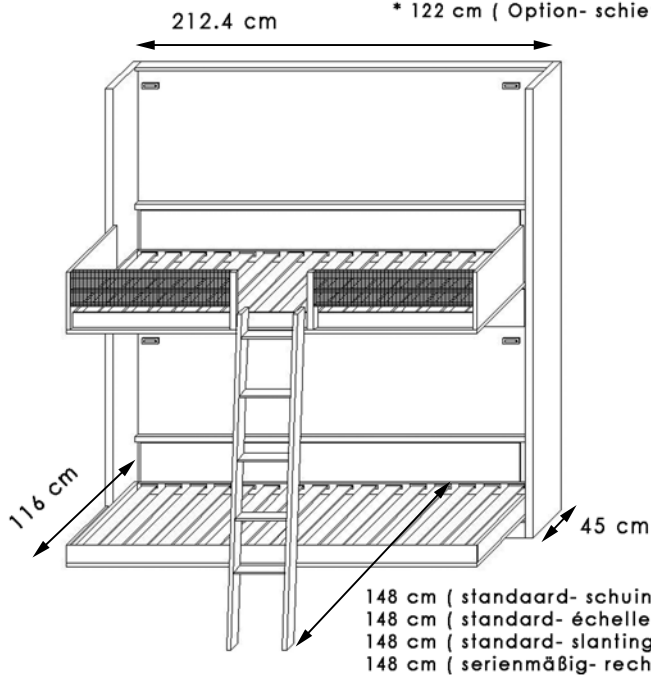

* 133 cm (optie- rechte ladder)
* 133 cm (option- échelle droite)
* 133 cm (option- straight ladder)
* 133 cm (Option- schiefe Leiter)

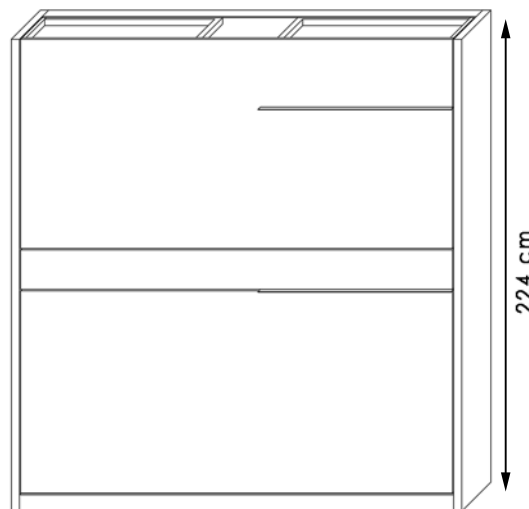

MAXIMALE MATRASDIKTE: 22 cm
Voor kinderkamers is een matrasdikte van 10 cm aangeraden zodat de veiligheidsomranding zich voldoende boven de matras bevindt.

EPAISSEUR MAXIMALE DU MATELAS : 22 cm
Pour les chambres d'enfant, une épaisseur de matelas de 10 cm est conseillée afin de garantir une sécurité tout autour du lit au-dessus du matelas.

MAXIMUM MATTRESS THICKNESS: 22 cm
We recommend the use of a mattress with a thickness of 10 cm for children's rooms so that the bed's safety perimeter is of sufficient height above the mattress.

MAX. MATRATZENDICKE: 22 cm
Für Kinderbetten wird eine Matratzendicke von 10 cm empfohlen, sodass die Sicherheitsumrandung ausreichend über die Matratze hinausragt.

Stevige muur is een absolute vereiste voor dit bed.
Alle bijgeleverde bevestigingsmateriaal moet gebruikt worden.

Un mur solide est une exigence absolue pour monter ce type de lit.
L'ensemble du matériel livré pour fixer le lit au mur doit être utilisé.

Ensuring that there is a solid wall before commencing assembly is an absolute must for this bed. All materials provided to attach the bed to the wall should therefore be used.

Das Bett muss an einer stabilen Wand befestigt werden.
Das im Lieferumfang enthaltene Befestigungsmaterial muss verwendet werden.



4.1 Lit rabattable superposé (couchage intérieur: 80x190cm)

	LIT		REF.	matelas
	BLANC+	REF.		
	ch.clair	1502T		polystretch 10, polyether , 38kg/m³, 80x190x10
	ch.foncé	1602T		02MAS
	noyer	1702T		masarat, Mousse à froid, 55kg/m³, 80x190x22cm
	blanc uni	1802T		

REF.	OPTION
1076	Éclairage LED (2 sets de 2 lumières) + connexion USB
B1076	Éclairage LED dans le bureau + connexion USB
BS02	Rembarde du lit habillée de tissu - beige

MATCH / HAUTE BRILLANCE

finition façade
 voir rubrique MATCH/ HAUTE BRILLANCE
 (3 façades, sécurité, échelle)
 couleurs laque
 blanc haute brillance

Choix entre deux échelles (gratuit) :

SL02	Echelle inclinée (standard) afin de faciliter la montée dans le lit
RL02	Echelle droite (option) en fonction de la place

4.2 Lit rabattable superposé (couchage intérieur: 90x200cm)

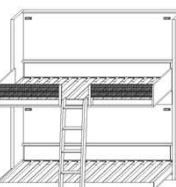
	LIT		REF.	matelas
	BLANC+	REF.		
	ch.clair	1504T		04POL
	ch.foncé	1604T		polystretch 10, polyether , 38 kg/m³, 90x200x10
	noyer	1704T		04MAS
	blanc uni	1804T		Masarat- polyether ,55 kg/m³, 90x200x22cm

REF.	OPTION
1076	Éclairage LED (2 sets de 2 lumières) + connexion USB
BS04	Rembarde du lit habillée de tissu - beige

MATCH / HAUTE BRILLANCE

finition façade
 voir rubrique MATCH/ HAUTE BRILLANCE
 (3 façades, sécurité, échelle)
 couleurs laque
 blanc haute brillance

Choix entre deux échelles (gratuit) :

SL04	Echelle inclinée (standard) afin de faciliter la montée dans le lit
RL04	Echelle droite (option) en fonction de la place

5. Pilasters & bibliotheken

5. Pilastres & bibliothèques

5. End panels & library units

5. Stollen & Bücherregalen

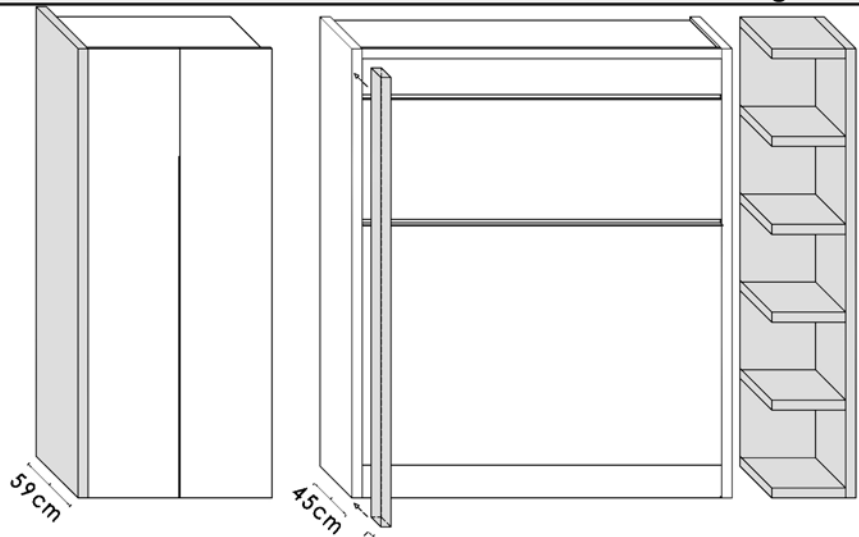

Aanbouwbibliotheek: 45cm diep
 Bibliothèque complémentaire: prof. 45cm
 Build-on library: depth 45cm
 Anbaubücherregal: Tiefe 45 cm

LOFT

Aanzetpilaster (D:14cm) voor diepteverschil bed-hangkast
 Pilastre d'ajoute (P:14cm) pour différence profondeur lit-garderobe
 Build-on end panel (D:14cm) for depth difference bed-wardrobe
 Anbaustollen (T:14 cm) aufgrund der unterschiedlichen Tiefe des Betts
 und des Kleiderschranks mit Kleiderstange

Pilaster: 59cm diep
 Pilastre: profondeur 59cm
 End panel: depth 59cm
 Stollen: Tiefe 59 cm

Links / Gauche / Left

Rechts / Droite / Right

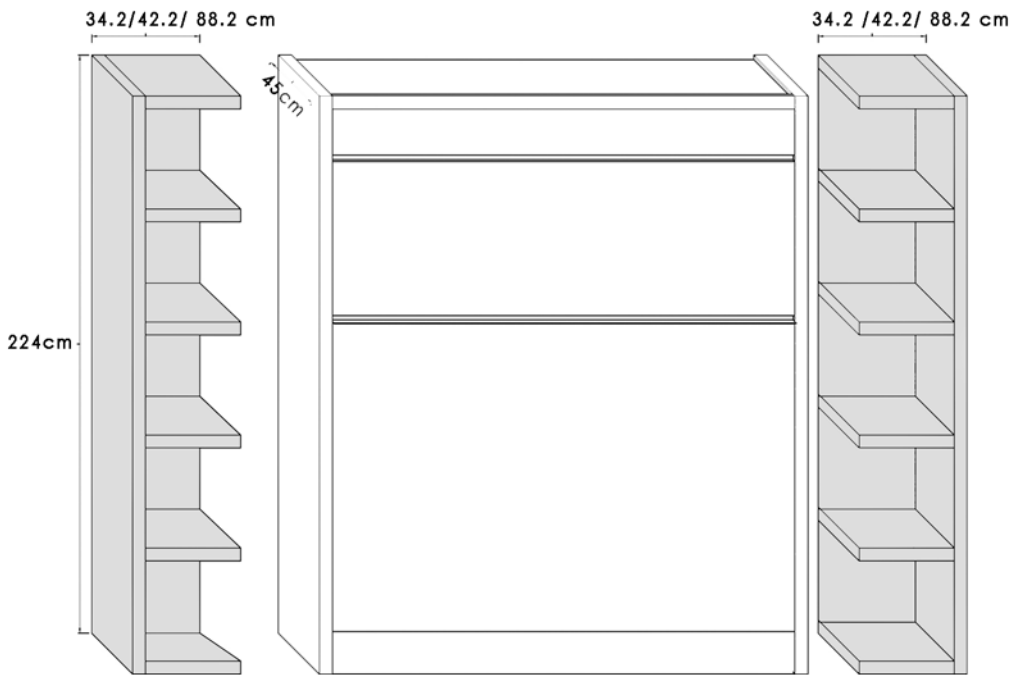



* ZIE OOK: SMART §3 voor verdere uitleg pilasters
 * VOIR AUSSI: SMART §3 pour autre renseignements pilastres
 * SEE ALSO: SMART § for further explication end panels
 * SIEHE AUCH: SMART §3 für mehr Informationen über Stollen

5. Pilastres & Bibliothèques

PILASTRE = 3,8 cm

PILASTRE Profondeur 45cm			
	coul. d'accent:	REF.	
	chêne clair	1568	
	chêne foncé	1668	
	noyer	1768	
	blanc (uni)	1868	

PILASTRE Profondeur 59cm			
	coul. d'accent:	REF.	
	chêne clair	1569	
	chêne foncé	1669	
	noyer	1769	
	blanc (uni)	1869	

PILASTRE D'AJOUTE LIT (Prof.14cm)			
	coul. d'accent:	REF.	
	chêne clair	1568A	
	chêne foncé	1668A	
	noyer	1768A	
	blanc (uni)	1868A	

BIBLIOTHEQUES PROFONDEUR 59 cm			
	coul. d'accent:	REF.	
	chêne clair	1520D	
	chêne foncé	1620D	
	noyer	1720D	
	blanc (uni)	1820D	

BIBLIOTHEQUES PROFONDEUR 45 cm

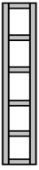
LARGEUR 38 CM			
	coul. d'accent:	REF.	
	chêne clair	1510	
	chêne foncé	1610	
	noyer	1710	
	blanc (uni)	1810	

LARGEUR 45 CM			
	coul. d'accent:	REF.	
	chêne clair	1520	
	chêne foncé	1620	
	noyer	1720	
	blanc (uni)	1820	

LARGEUR 92 CM			
	coul. d'accent:	REF.	
	chêne clair	1550	
	chêne foncé	1650	
	noyer	1750	
	blanc (uni)	1850	

LARGEUR 34,2 cm (gauche)			
	coul. d'accent:	REF.	
	chêne clair	1510L	
	chêne foncé	1610L	
	noyer	1710L	
	blanc (uni)	1810L	

LARGEUR 34,2 cm (droite)			
	coul. d'accent:	REF.	
	chêne clair	1510R	
	chêne foncé	1610R	
	noyer	1710R	
	blanc (uni)	1810R	

LARGEUR 43,2 cm (gauche)			
	coul. d'accent:	REF.	
	chêne clair	1520L	
	chêne foncé	1620L	
	noyer	1720L	
	blanc (uni)	1820L	

LARGEUR 43,2 cm (droite)			
	coul. d'accent:	REF.	
	chêne clair	1520R	
	chêne foncé	1620R	
	noyer	1720R	
	blanc (uni)	1820R	

LARGEUR 88,2 cm (gauche)			
	coul. d'accent:	REF.	
	chêne clair	1550L	
	chêne foncé	1650L	
	noyer	1750L	
	blanc (uni)	1850L	

LARGEUR 88,2 cm (droite)			
	coul. d'accent:	REF.	
	chêne clair	1550R	
	chêne foncé	1650R	
	noyer	1750R	
	blanc (uni)	1850R	

6. Hangkasten & legkasten

6. Garderobes & lingères

6. Wardrobes & cupboards

6. Kleiderschrank & Schrank mit Einlegeböden

6.A. Hangkasten / Garderobes / Wardrobes/ Kleiderschrank

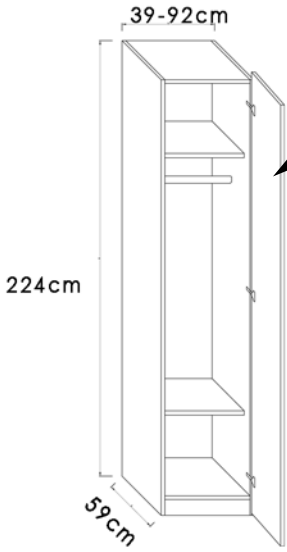

- 2 legplanken + kastbaar inbegrepen
- 2 étagères + tringle inclus
- 2 shelves + hanging rail included
- 2 Einlegeböden + inklusive Kleiderstange

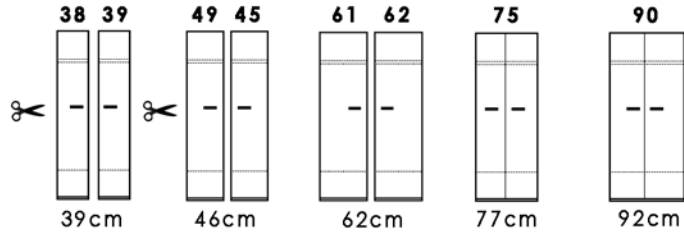

LOFT

6.B. Legkasten / Lingères / Cupboards/ Schrank mit Einlegeböden

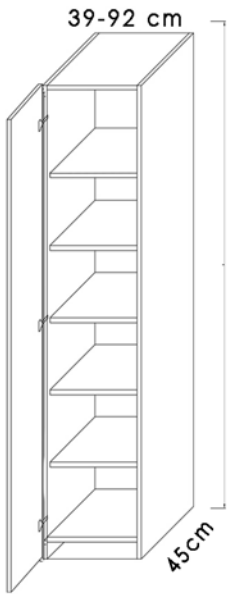

- 5 legplanken inbegrepen
- 5 étagères inclus
- 5 shelves included
- 5 Einlegeböden inklusive

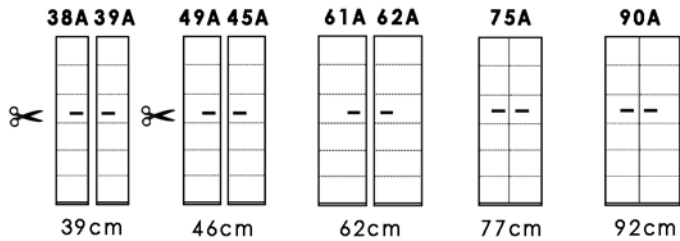

Voor maatwerk: minimum 4cm van de standaardmaat aftrekken
 Armoire sur mesure: décompter un minimum de 4cm de la mesure standard
 Cut to size: minimum deduction of 4cm required
 Bei Spezialanfertigungen: mindestens 4 cm von den Standardmaßen abziehen

6.C. Hoekkasten / Armoires d'angle / Corner wardrobes/ Eckschränken

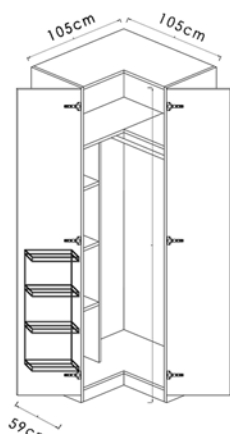
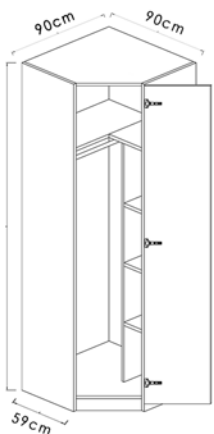

6.A. Garderobes (Profondeur 59cm)

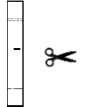
39cm (gauche)	REF.	
 blanc	1038	

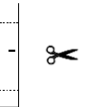
46cm (gauche)	REF.	
 blanc	1049	

62cm (gauche)	REF.	
 blanc	1061	

39cm (droite)	REF.	
 blanc	1039	

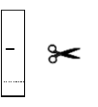
46cm (droite)	REF.	
 blanc	1045	

62cm (droite)	REF.	
 blanc	1062	

77cm	REF.	
 blanc	1075	

92cm	REF.	
 blanc	1090	

+ PILASTRES!		
voir page précédente		

6.B. Lingères (profondeur 45cm)

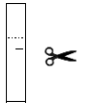
39cm (gauche)	REF.	
 blanc	1038A	

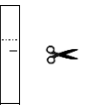
46cm (gauche)	REF.	
 blanc	1049A	

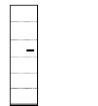
62cm (gauche)	REF.	
 blanc	1061A	

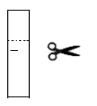
39cm (droite)	REF.	
 blanc	1039A	

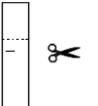
46cm (droite)	REF.	
 blanc	1045A	

62cm (droite)	REF.	
 blanc	1062A	

77cm	REF.	
 blanc	1075A	

92cm	REF.	
 blanc	1090A	

+ PILASTERS!		
voir page précédente		

 SUR MESURE (L, P, H)
= supplément:
décompter au minimum 4cm de la mesure standard

OPTIONS
étagère, tringle, rangement int. bloc tiroir,... VOIR RUBRIQUE OPTIONS

MATCH
voir rubrique MATCH
39-46cm - couleurs laque
62-92cm - couleurs laque
39-46cm - bl. haute brill.
62-92cm - bl. haute brill.

6.C. Armoires d'angle

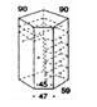
90x90cm	REF.	
 blanc	1018	

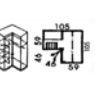
105x105cm	REF.	
 blanc	H1015	

MATCH
voir rubrique MATCH
90x90cm - couleurs laque
105x105cm - coul. laque
90x90cm - bl. haute brill.
105x105cm - bl. haute brill.