

BOONE

INTERNATIONAL



NIJVERHEIDSSTRAAT 14
8970 POPERINGE
☎ (+32) 57 33 45 01

VERKOOP@BOONE.BE
VAT BE0428.180.665
WWW.BOONE.BE

3. SAVANNA- Horizontale opklapbedden - diepte 45 cm

3. SAVANNA- Lits rabattables horizontaux - profondeur 45 cm

3. SAVANNA- Horizontal wallbeds - depth 45 cm

3. SAVANNA- Horizontale Klappbetten - Tiefe 45 cm

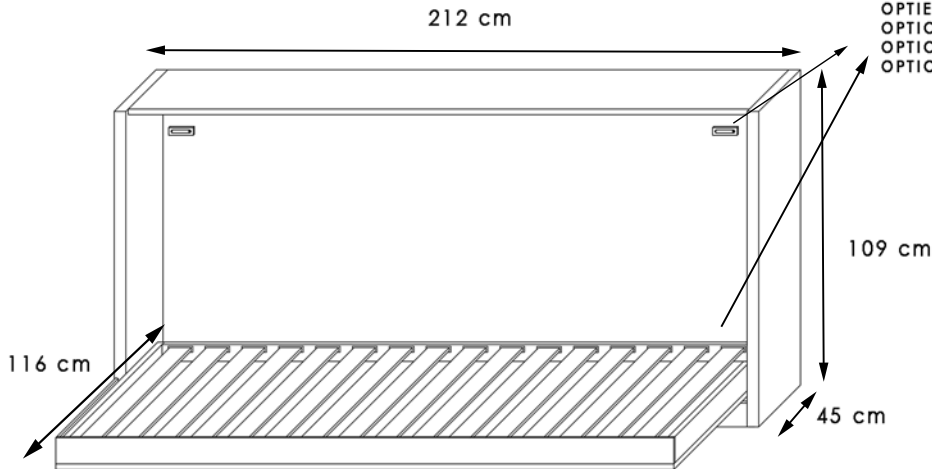

OPTIE: LED verlichting (aan beide zijden) + USB aansluiting
OPTION: Eclairage LED (à chaque côté) + USB connexion
OPTION: LED Lights (on both sides)+ USB connection
OPTION: Leseleuchten (an beiden Seiten) + USB Anschluss

LOFT

Lattenbodem met dubbele rotulen
Sommier à lattes avec double rotules.
Slatted base with double slat holders
Lattenboden mit doppelten Lattenhaltern



Optie: matras 90 x 200 cm
Option: matelas 90 x 200 cm
Option: mattress 90 x 200 cm
Option: Matratze 90x200 cm



Maximale matrasdikte : 22 cm
Epaisseur maximale: 22 cm
Maximum thickness: 22 cm
Max. Matratzenhöhe: 22 cm



Maximaal gewicht = 100 kg
Poids max = 100 kg
Max.weight = 100g
Maximale Belastung = 100 kg



Bed moet bevestigd worden aan een sterke muur.
Le lit doit être fixé sur un mur robuste.
Bed must be fastened to a solid wall.
Das Bett muss an einer stabilen Wand befestigt werden.

3.1 Lit rabattable horizontal 1 personne (couchage intérieur: 90x200cm)

	LIT		REF.	matelas
	BLANC+	REF.	04MAS	Masarat, Mousse à froid, HR60 (souple) 90x200x22cm
	ch.clair	1504L	04MAS+	Masarat, Mousse à froid, HR55 (ferme) 90x200x22cm
	ch.foncé	1604L	04AMB	Ambiance, Pocket, HR60 (souple) 90x200x21cm
	noyer	1704L	04AMB+	Ambiance, Pocket, HR55 (ferme) 90x200x21cm
blanc uni	1804L			
				MATCH / HAUTE BRILLANCE
				finition façade voir rubrique MATCH couleurs laque blanc haute brillance
REF	OPTION			
S1076	Éclairage LED (set de 2 lumières)			

5. Pilasters & bibliotheken

5. Pilastres & bibliothèques

5. End panels & library units

5. Stollen & Bücherregalen

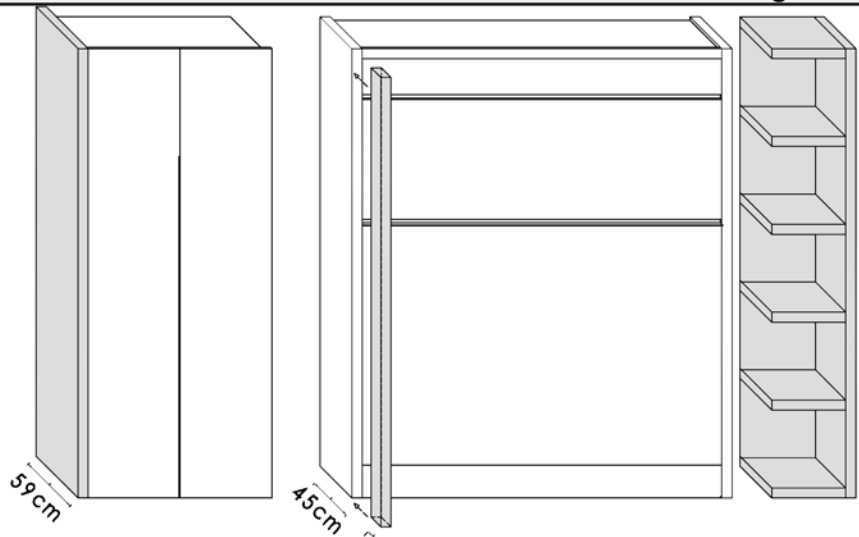

Aanbouwbibliotheek: 45cm diep
 Bibliothèque complémentaire: prof. 45cm
 Build-on library: depth 45cm
 Anbaubücherregal: Tiefe 45 cm

Aanzetpilaster (D:14cm) voor diepteverschil bed-hangkast
 Pilastre d'ajoute (P:14cm) pour différence profondeur lit-garderobe
 Build-on end panel (D:14cm) for depth difference bed-wardrobe
 Anbaustollen (T:14 cm) aufgrund der unterschiedlichen Tiefe des Betts
 und des Kleiderschranks mit Kleiderstange

Pilaster: 59cm diep
 Pilastre: profondeur 59cm
 End panel: depth 59cm
 Stollen: Tiefe 59 cm

Links / Gauche / Left

Rechts / Droite / Right

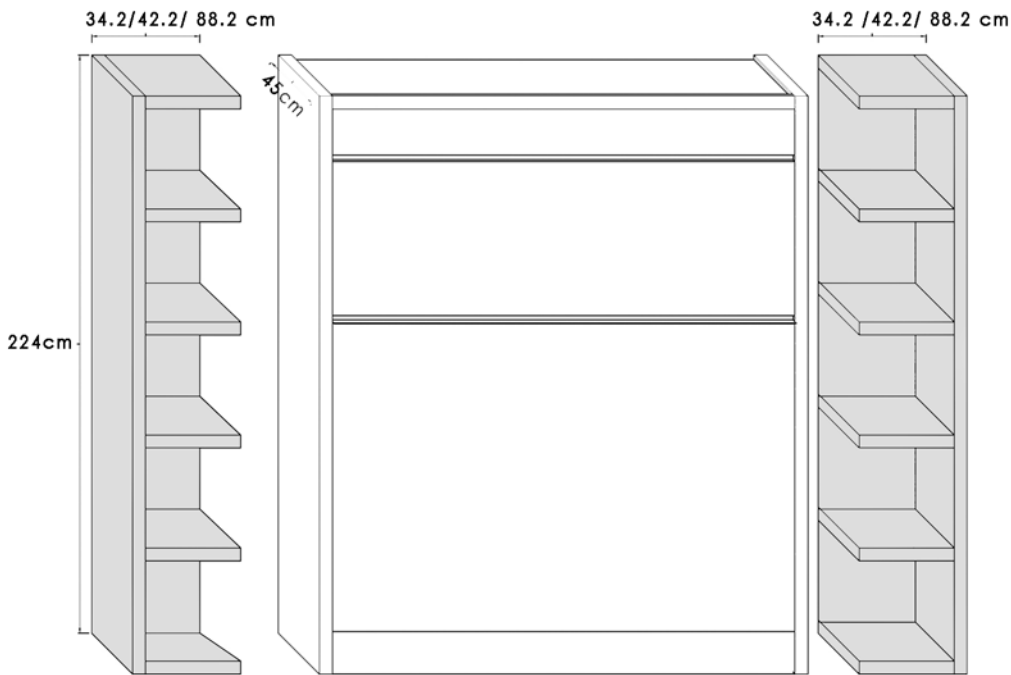



* ZIE OOK: SMART §3 voor verdere uitleg pilasters
 * VOIR AUSSI: SMART §3 pour autre renseignements pilastres
 * SEE ALSO: SMART § for further explication end panels
 * SIEHE AUCH: SMART §3 für mehr Informationen über Stollen

5. Pilastres & Bibliothèques

PILASTRE = 3,8 cm

PILASTRE Profondeur 45cm			
	coul. d'accent:	REF.	
	chêne clair	1568	
	chêne foncé	1668	
	noyer	1768	
	blanc (uni)	1868	

PILASTRE Profondeur 59cm			
	coul. d'accent:	REF.	
	chêne clair	1569	
	chêne foncé	1669	
	noyer	1769	
	blanc (uni)	1869	

PILASTRE D'AJOUTE LIT (Prof.14cm)			
	coul. d'accent:	REF.	
	chêne clair	1568A	
	chêne foncé	1668A	
	noyer	1768A	
	blanc (uni)	1868A	

BIBLIOTHEQUES PROFONDEUR 59 cm			
	coul. d'accent:	REF.	
	chêne clair	1520D	
	chêne foncé	1620D	
	noyer	1720D	
	blanc (uni)	1820D	

BIBLIOTHEQUES PROFONDEUR 45 cm

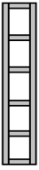
LARGEUR 38 CM			
	coul. d'accent:	REF.	
	chêne clair	1510	
	chêne foncé	1610	
	noyer	1710	
	blanc (uni)	1810	

LARGEUR 45 CM			
	coul. d'accent:	REF.	
	chêne clair	1520	
	chêne foncé	1620	
	noyer	1720	
	blanc (uni)	1820	

LARGEUR 92 CM			
	coul. d'accent:	REF.	
	chêne clair	1550	
	chêne foncé	1650	
	noyer	1750	
	blanc (uni)	1850	

LARGEUR 34,2 cm (gauche)			
	coul. d'accent:	REF.	
	chêne clair	1510L	
	chêne foncé	1610L	
	noyer	1710L	
	blanc (uni)	1810L	

LARGEUR 34,2 cm (droite)			
	coul. d'accent:	REF.	
	chêne clair	1510R	
	chêne foncé	1610R	
	noyer	1710R	
	blanc (uni)	1810R	

LARGEUR 43,2 cm (gauche)			
	coul. d'accent:	REF.	
	chêne clair	1520L	
	chêne foncé	1620L	
	noyer	1720L	
	blanc (uni)	1820L	

LARGEUR 43,2 cm (droite)			
	coul. d'accent:	REF.	
	chêne clair	1520R	
	chêne foncé	1620R	
	noyer	1720R	
	blanc (uni)	1820R	

LARGEUR 88,2 cm (gauche)			
	coul. d'accent:	REF.	
	chêne clair	1550L	
	chêne foncé	1650L	
	noyer	1750L	
	blanc (uni)	1850L	

LARGEUR 88,2 cm (droite)			
	coul. d'accent:	REF.	
	chêne clair	1550R	
	chêne foncé	1650R	
	noyer	1750R	
	blanc (uni)	1850R	

6. Hangkasten & legkasten

6. Garderobes & lingères

6. Wardrobes & cupboards

6. Kleiderschrank & Schrank mit Einlegeböden

6.A. Hangkasten / Garderobes / Wardrobes/ Kleiderschrank

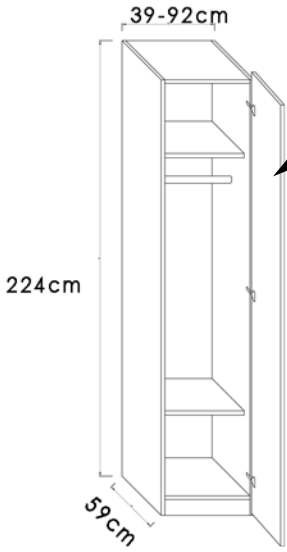

- 2 legplanken + kastbaar inbegrepen
- 2 étagères + tringle inclus
- 2 shelves + hanging rail included
- 2 Einlegeböden + inklusive Kleiderstange

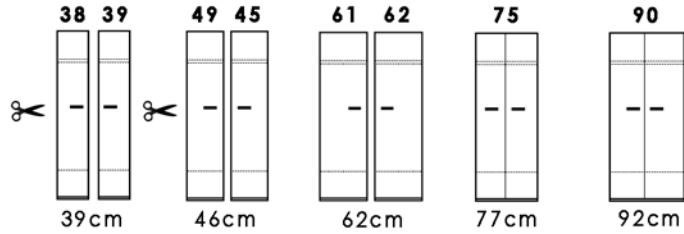

LOFT

6.B. Legkasten / Lingères / Cupboards/ Schrank mit Einlegeböden

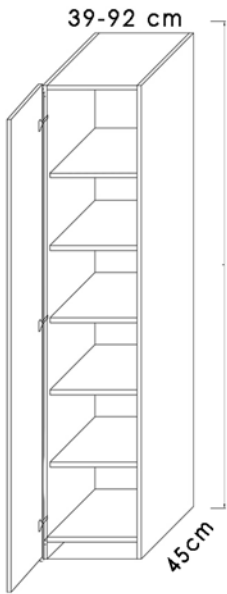

- 5 legplanken inbegrepen
- 5 étagères inclus
- 5 shelves included
- 5 Einlegeböden inklusive

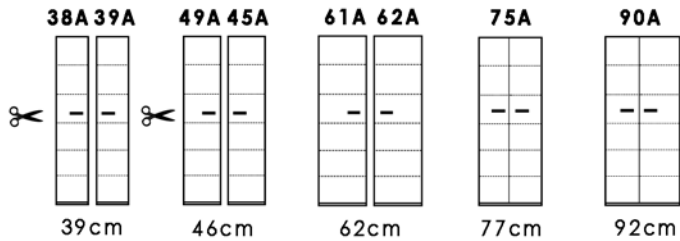

Voor maatwerk: minimum 4cm van de standaardmaat aftrekken
 Armoire sur mesure: décompter un minimum de 4cm de la mesure standard
 Cut to size: minimum deduction of 4cm required
 Bei Spezialanfertigungen: mindestens 4 cm von den Standardmaßen abziehen

6.C. Hoekkasten / Armoires d'angle / Corner wardrobes/ Eckschränken

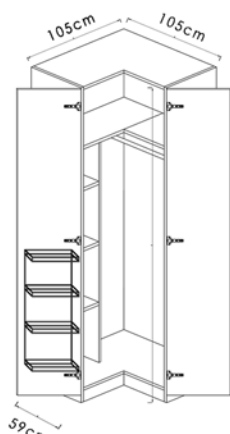
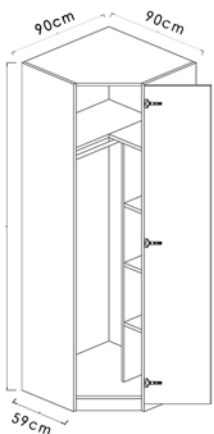

6.A. Garderobes (Profondeur 59cm)

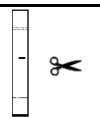
39cm (gauche)	REF.		
	blanc	1038	

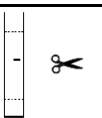
46cm (gauche)	REF.		
	blanc	1049	

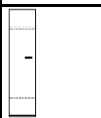
62cm (gauche)	REF.		
	blanc	1061	

39cm (droite)	REF.		
	blanc	1039	

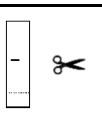
46cm (droite)	REF.		
	blanc	1045	

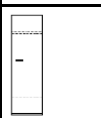
62cm (droite)	REF.		
	blanc	1062	

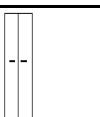
77cm	REF.		
	blanc	1075	

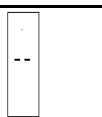
92cm	REF.		
	blanc	1090	

+ PILASTRES!			
voir page précédente			

6.B. Lingères (profondeur 45cm)

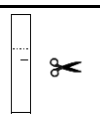
39cm (gauche)	REF.		
	blanc	1038A	

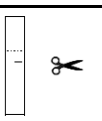
46cm (gauche)	REF.		
	blanc	1049A	

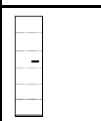
62cm (gauche)	REF.		
	blanc	1061A	

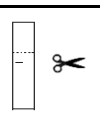
39cm (droite)	REF.		
	blanc	1039A	

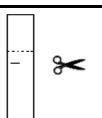
46cm (droite)	REF.		
	blanc	1045A	

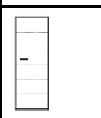
62cm (droite)	REF.		
	blanc	1062A	

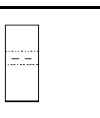
77cm	REF.		
	blanc	1075A	

92cm	REF.		
	blanc	1090A	

+ PILASTERS!			
voir page précédente			

 SUR MESURE (L, P, H)			
= supplément:			
décompter au minimum 4cm de la mesure standard			

OPTIONS			
étagère, tringle, rangement int. bloc tiroir,...			
VOIR RUBRIQUE OPTIONS			

MATCH			
voir rubrique MATCH			
39-46cm - couleurs laque			
62-92cm - couleurs laque			
39-46cm - bl. haute brill.			
62-92cm - bl. haute brill.			

6.C. Armoires d'angle

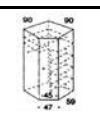
90x90cm	REF.		
	blanc	1018	

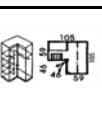
105x105cm	REF.		
	blanc	H1015	

MATCH			
voir rubrique MATCH			
90x90cm - couleurs laque			
105x105cm - coul. laque			
90x90cm - bl. haute brill.			
105x105cm - bl. haute brill.			